

# Ultra Dispense Components

The correct selection of syringe barrel, piston and dispense tip provides complete fluid application control, safe, easy, no drip or ooze.

## pistons

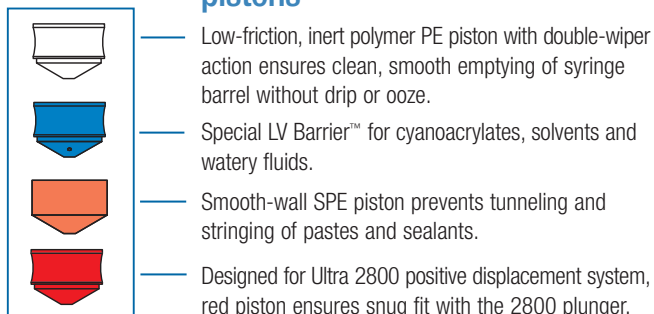

## syringe barrels

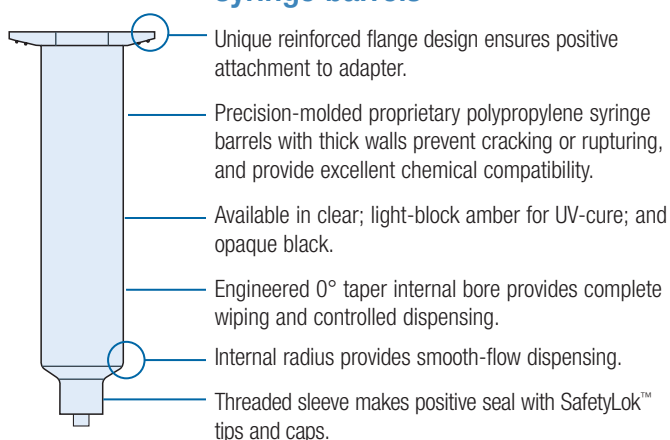

## dispense tips

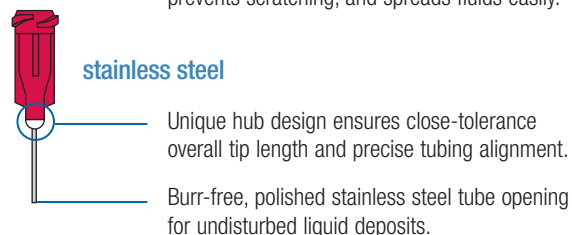
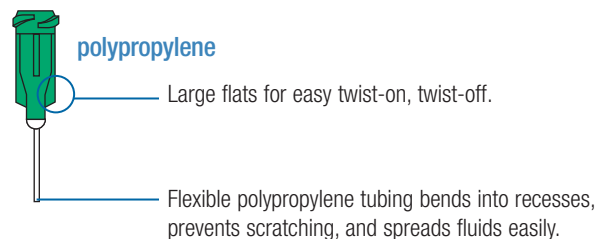
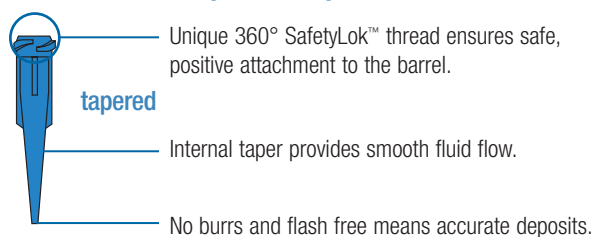

## Benefits

- ◆ Molded silicone-free
- ◆ Certified safe for industrial use
- ◆ Positive dispense cutoff
- ◆ Disposable, no cleanup
- ◆ Closed system
- ◆ High-strength copolymer

## Shipments

All Ultra components are shipped from stock within 24 hours of receipt of order.

## Quality Assurance

EFD certifies that all EFD components are designed for safe industrial operation when used in accordance with our technical data, manuals and brochures. EFD certifies that all components are precision molded in an EFD silicone-free facility.

**Barrel dimensions**

	A	B
3CC	1.1 cm (7/16")	7.3 cm (2 7/8")
5CC	1.4 cm (9/16")	6.8 cm (2 11/16")
10cc	1.9 cm (3/4")	8.9 cm (3 1/2")
30cc	2.5 cm (1")	11.6 cm (4 9/16")
55cc	2.5 cm (1")	17.3 cm (6 13/16")

# Disposable Reservoir System



Five sizes, three colors and four types of syringe barrels/pistons make up the Ultra reservoir system for proper dispensing of all kinds of assembly fluids.

For samples, recommendations and immediate customer service:  
[info@efd-inc.com](mailto:info@efd-inc.com) [www.efd-inc.com/samples](http://www.efd-inc.com/samples)

## Syringe barrel & piston sets

QTY	MOST FLUIDS			Light Block*	Opaque
	Clear Barrels White Pistons	Clear Barrels Blue LV™ Barrier	Clear Barrels Red Pistons	Amber Barrels White Pistons	Black Barrels White Pistons
3cc (50)	5109CP-B	5109LV-B	5109CPD-B	5109LBP-B	5109UP-B
5cc (40)	5110CP-B	n/a	5110CPD-B	5110LBP-B	5110UP-B
10cc (30)	5111CP-B	5111LV-B	5111CPD-B	5111LBP-B	5111UP-B
30cc (20)	5112CP-B	n/a	5112CPD-B	5112LBP-B	5112UP-B
55cc (15)	5113CP-B	n/a	n/a	5113LBP-B	5113UP-B

Reservoirs available in clear for most fluids; translucent amber for UV and light-sensitive materials (\*240 to 550 nm); and opaque black to ensure complete light blockage.

Amber barrels also available with red pistons; request the LBP series. LV Barrier sets include tip caps and are designed for cyanoacrylate and very low viscosity fluid dispensing. Red PD pistons are for use with the Ultra 2800 positive displacement system.

## Storage end/tip caps

QTY	End Cap
3cc (50)	5109EC-B
5cc (40)	5110EC-B
10cc (30)	5111EC-B
30cc (20)	5112EC-B
55cc (20)	5112EC-B

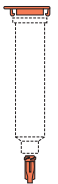

QTY	Tip Cap
All sizes (50)	5113-B

Snap-on end cap for leakproof barrel sealing. Opaque SafetyLok™ tip caps fit all barrel sizes.

## Syringe barrels without pistons

QTY	Clear Barrels	Light Block Amber Barrels	Opaque Black Barrels
3cc (50)	5109LL-B	5109LB-B	5109UV-B
5cc (40)	5110LL-B	5110LB-B	5110UV-B
10cc (30)	5111LL-B	5111LB-B	5111UV-B
30cc (20)	5112LL-B	5112LB-B	5112UV-B
55cc (15)	5113LL-B	5113LB-B	5113UV-B

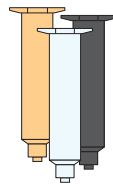

**Note:** Order appropriate SmoothFlow pistons separately.

## SmoothFlow™ barrel pistons

QTY	White PE	Blue LV	Orange SPE	Red
3cc (50)	5109PE-B	5109LVP-B	5109SPE-B	5109PDP-B
5cc (40)	5110PE-B	n/a	5110SPE-B	5110PDP-B
10cc (30)	5111PE-B	5111LVP-B	5111SPE-B	5111PDP-B
30cc (20)	5112PE-B	n/a	5112SPE-B	5112PDP-B
55cc (20)	5112PE-B	n/a	5112SPE-B	5112PDP-B



Pistons ensure constant dispensing force, prevent drip or ooze, contain hazardous fumes and empty all fluid from barrel.

## Adapter assemblies

QTY	Yellow Acetal	Yellow Acetal	Yellow Acetal
	0.9m (3ft) Hose	1.8m (6ft) Hose	0.9m (3ft) Hose/Trap
3cc (1)	1000Y5148	1000Y5148-6	1000Y-5148-F
5cc (1)	1000Y5149	1000Y5149-6	1000Y-5149-F
10cc (1)	1000Y5150	1000Y5150-6	1000Y-5150-F
30/55cc (1)	1000Y5152	1000Y5152-6	1000Y-5152-F

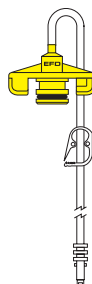

One-piece molded SnapLok™ adapter provides safe attachment of syringe barrel. Includes 0.4 cm (5/32") OD flexible polyurethane tubing, Buna N O-ring, quick-connect and safety clip.

**Note:** Refer to price list for replacement parts.

## ESD-safe components

Unique barrel/dispense tip/adaptor systems are manufactured to ensure static electricity is dissipated, offering high conductivity and low carbon black loading. ESD-safe components are ideal for dispensing adhesives and epoxies in electronics, disk drive and SMT production.

**Free samples and ESD Test Report:**  
[email info@efd-inc.com](mailto:info@efd-inc.com)

“We have made a **huge leap** from bottleneck to high production.” Pat Welch, Ethicon Endo Surgery

# Precision Dispense Tips



After choosing the most appropriate dispenser and barrel/piston combination, the deposit is defined by the type of dispense tip selected.

Each EFD tip is precision made, without burrs or flash, to produce the very best deposit control.



Transparent boxes keep tips clean, handy and easy to identify.

## Smooth-flow tapered tips (50 tips per box)

gauge	standard	opaque rigid	color
14	5114TT-B	5114RTT-B	Olive
16	5116TT-B	5116RTT-B	Grey
18	5118TT-B	5118RTT-B	Green
20	5120TT-B	5120RTT-B	Pink
22	5122TT-B	5122RTT-B	Blue
25	5125TT-B	5125RTT-B	Red



Use with gel cyanoacrylates, UV-cure adhesives, sealants, and particle-filled materials or any medium to high viscosity fluid. Molded of polyethylene with UV-light block additive.

## Flexible tips (50 tips per box)

gauge	12.7 mm (0.50")	38.1 mm (1.5")	color
15	5115PPS-B	5115PP-B	Amber
18	5118PPS-B	5118PP-B	Green
20	5120PPS-B	5120PP-B	Pink
25	5125PPS-B	5125PP-B	Red

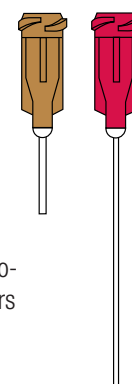

Flexible polypropylene tubing for application into difficult-to-access areas. Easily drags along edges and around corners and prevents scratching. Tubing can be cut to length.

## Precision stainless steel tips (50 tips per box)

gauge	6.35mm (0.25")	12.7mm (0.50")	25.4mm (1.0")	38.1mm (1.5")	45°/12.7mm (0.5")	90°/12.7mm (0.5")	45°/38.1mm (1.5")	color
14	5114-0.25-B	5114-B	5114-1-B	5114-1.5-B	5114-B-45	5114-B-90	2173-B	Olive
15	5115-0.25-B	5115-B	5115-1-B	5115-1.5-B	5115-B-45	5115-B-90	n/a	Amber
18	5118-0.25-B	5118-B	5118-1-B	5118-1.5-B	5118-B-45	5118-B-90	2174-B	Green
20	5120-0.25-B	5120-B	5120-1-B	5120-1.5-B	5120-B-45	5120-B-90	n/a	Pink
21	5121-0.25-B	5121-B	5121-1-B	5121-1.5-B	5121-B-45	5121-B-90	2175-B	Purple
22	5122-0.25-B	5122-B	5122-1-B	5122-1.5-B	5122-B-45	5122-B-90	n/a	Blue
23	5123-0.25-B	5123-B	5123-1-B	5123-1.5-B	5123-B-45	5123-B-90	n/a	Orange
25	5125-0.25-B	5125-B	5125-1-B	5125-1.5-B	5125-B-45	5125-B-90	n/a	Red
27	5127-0.25-B	5127-B	n/a	n/a	5127-B-45	5127-B-90	n/a	Clear
30	5130-0.25-B	5130-B	n/a	n/a	5130-B-45	5130-B-90	n/a	Lavender
32	5132-0.25-B	n/a	n/a	n/a	n/a	n/a	n/a	Yellow

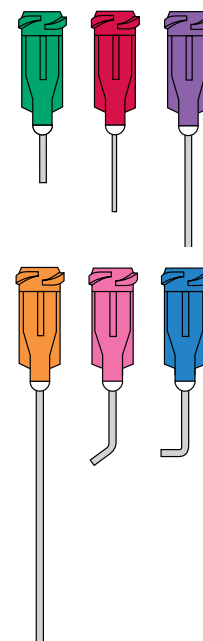

Burr-free, polished, passivated stainless steel dispense tips with polypropylene SafetyLok™ hubs for a secure fit to barrel reservoirs.

• 6.35 mm (0.25") tips: Fast point-to-point dispensing. • Smaller gauges ideal for microdots. • 12.7 mm (0.50") tips: Standard all-around precision dispense tips. • 25.4 mm (1"), 38.1 mm (1.5"), 45° and 90° tips: Easy access into hard-to-reach areas.





[www.efd-inc.com](http://www.efd-inc.com) [info@efd-inc.com](mailto:info@efd-inc.com)

USA 800-556-3484 Europe +44 (0) 1582 666334 Asia +86 (21) 5854 2345

Sales and service of EFD® dispensing systems are available worldwide.

# Precision Dispense Tips

## PTFE-lined tips (50 tips per box)

ID	12.7 mm (0.50")	25.4 mm (1.0")	color
0.020"	5121TLCS-B	5121TLC-B	Grey 
0.006"	5125TLCS-B	5125TLC-B	Pink 

Resists clogging of cyanoacrylates.  
Use for microdot application of low viscosity fluids.

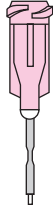

## Oval tips (50 tips per box)



gauge	12.7 mm (0.50")	color
15	51150VAL-B	Amber 

Makes flat ribbon deposits of thick pastes, sealants and epoxies.

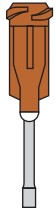
Outlet size is 1.98 x 0.41 mm (.078" x .016").



## PTFE-coated tips (20 tips per box)

gauge	ID	OD	12.7 mm (0.50")	color
21	0.020	0.033	5121PC-B	Purple 
23	0.013	0.026	5123PC-B	Orange 

Controls wicking to stop drips for optical media applications.





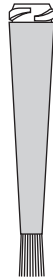

## Brush tips (sold individually)

style	standard	high flow
soft bristle	5140A	5140HF
stiff bristle	5141A	5141HF

Spread glues and greases. Nylon bristles, 50.8 mm (2") length.



## Chamfered tips



gauge	12.7 mm (0.50")	color
18	5118CH-B (50)	Green 
23	5123CH-B (50)	Orange 
25	5125CH-B (50)	Red 
33	5133MD-B*(25)	Black 

Resists clogging of cyanoacrylates.  
Use for microdot application of low viscosity fluids.

\*5133MD-B is 6.35 mm (0.25") long









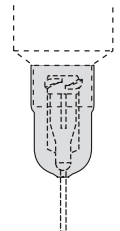





## Tip shields (10 shields per box)

size	shield	color
3cc	5105	Red 
5cc to 55cc	5106	Black 

Reusable tip shields for light-sensitive and UV-cure adhesives. Fits over dispensing tip hub.



## Color coding for tip sizes

Color	Gauge	Inner Dia.		Outer Dia.	
		inch	mm	inch	mm
	Olive <b>14</b>	.060	1.54	.072	1.83
	Amber <b>15</b>	.053	1.36	.065	1.65
	Grey <b>16</b>	.047	1.19	n/a	n/a
	Green <b>18</b>	.033	0.84	.050	1.27
	Pink <b>20</b>	.024	0.61	.036	0.91
	Purple <b>21</b>	.020	0.51	.032	0.82
	Blue <b>22</b>	.016	0.41	.028	0.72
	Orange <b>23</b>	.013	0.33	.025	0.65
	Red <b>25</b>	.010	0.25	.020	0.52
	Clear <b>27</b>	.008	0.20	.016	0.42
	Lavender <b>30</b>	.006	0.15	.012	0.31
	Yellow <b>32</b>	.004	0.10	.009	0.24

Note: OD dimensions: stainless tips only

Whatever tip style, all sizes are color coded to ensure the specified size is used.



## Free Syringe & Tip Poster for Adhesive Dispensing.

Quickly identify the right dispensing components for your fluid application process.

Chart shows how to select the best syringe & tip combination to ensure complete fluid control. Post in tool cribs and at workstations.

Request online at [www.efd-inc.com/poster](http://www.efd-inc.com/poster)

## All shipments made within 24 hours.

# Precision Dispense Tips Selection



Taking time to match your specific application requirement and assembly fluid with the most suitable dispense tip is well worth the effort. We supply an appropriate assortment of tip types and sizes with each dispenser and valve.

For additional samples or recommendations and immediate customer service:  
[info@efd-inc.com](mailto:info@efd-inc.com) [www.efd-inc.com/samples](http://www.efd-inc.com/samples)

Applications	tapered	precision stainless steel tube	flexible	crimped PTFE-lined
Very low viscosity fluids	■	●	●	●
Particle-filled pastes	●	●	▲	■
Microdot deposits	■	●	▲	●
Fluid is reactive to metal	●	■	●	●
Depositing in recesses	▲	●	●	▲
Spreading/smearing	●	▲	●	▲
Fast-curing glues	●	▲	●	●
Beading, striping	●	●	●	▲
To avoid scratching	●	▲	●	●

Liquid/fluid/paste	tapered	precision stainless steel tube	flexible	crimped PTFE-lined
Adhesives	●	●	●	●
Anaerobics	●	▲	●	▲
Conformal Coatings	●	▲	▲	■
Cyanoacrylates	●	▲	●	●
Gel cyanoacrylates	●	▲	●	▲
Epoxies	●	●	●	■
Greases	●	●	●	■
Light-cure adhesives	■	▲*	▲*	■
Oils	▲	●	●	▲
Paints	▲	●	●	■
Sealants	●	▲	▲	■
Silver epoxy	■	▲+	■	■
Solder creams/braze pastes	●	●	▲	■
Solder masks	●	●	▲	■
Solvents	■	●	●	●
UV-cure adhesives	●	▲*	▲*	▲

**Key**

- Recommended
- ▲ Satisfactory
- Do not use

\* OK if used with tip shield, part# 5105 or 5106. See page 14.  
 + Chamfered tips are recommended for best results.

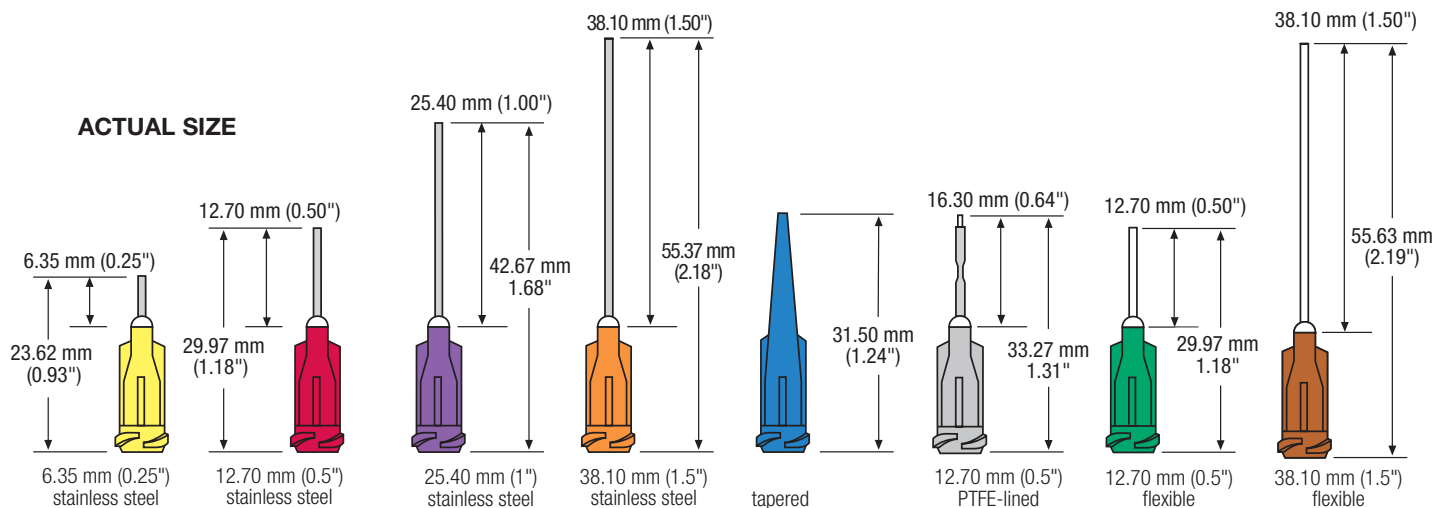

Dispense tip dimensions are for reference. See EFD sales drawing for exact specifications.